

# FORMULA STEERING WHEEL User Manual



Racing Data Power

## To the owner of Formula Steering wheel

The new **Formula Steering Wheel** belongs to the last generation of AIM dashes for car racings and provides the driver with an high technology steering wheel with an innovative design.

With anodised chassis, ergonomically shaped, hand-woven suede covered the Formula Steering Wheel has a real “racing look”.

Thanks to AIM ECT (Easy Connection Technology), the connection with AIM products and external expansion modules comes in a click.

Formula Steering Wheel allows to monitor RPM, speed, engaged gear, lap (split) times and custom sensors.

**Formula Steering Wheel**, moreover, is configurable with **Race Studio 2** software, that can be freely downloaded from [www.aim-sportline.com](http://www.aim-sportline.com).

## INDEX

<b>Chapter 1 – Characteristics and part number .....</b>	<b>4</b>
1.1 – Part Number .....	4
<b>Chapter 2 – How to connect Formula Steering wheel to EVO .....</b>	<b>5</b>
2.1 – Connection with EVO3 Pro .....	5
2.2 – Connection with EVO3 Pista/EVO4 .....	5
2.3 – Connection with other AIM peripherals .....	5
<b>Chapter 3 – Menu functions.....</b>	<b>6</b>
3.1 – Backlight.....	7
3.2 – Control Panel.....	7
3.2.1 – <i>Split</i> .....	7
3.2.2 – <i>Restart Gear Calib</i> .....	8
3.2.3 – <i>System Information</i> .....	8
3.3 – Hour Meter (EVO4 only).....	8
3.4 – Clear Test Data (EVO4 only) .....	9
3.5 – How to set GPS Lap timer (EVO4 or EVO3 Pro/Pista with external GPS Module only).....	9
<b>Chapter 4 – On track visualization .....</b>	<b>11</b>
<b>Chapter 5 – Data recall .....</b>	<b>12</b>
<b>Chapter 6 – Configuring the steering wheel.....</b>	<b>14</b>
<b>Appendix – technical drawings .....</b>	<b>15</b>

## Chapter 1 – Characteristics and part number



This dash merges an high technology steering wheel with an high design dash.

Thanks to the green or amber back-lighted display, all data are available at a glance:

- Lap time and lap number
- Speed or digital RPM value
- RPM graph bar
- 5 shift lights led
- 4 fully configurable alarm led
- 4 channels shown (two by two) between these available.

In addition, it is possible, through the four green buttons, to remote up to four functions like neutral signal, radio, speed limiter, launch control or other functions.

**Warning: le functionalities described in this tutorial have been implemented from firmware version 38.12 onward.**

### 1.1 – Part Number

Formula Steering Wheel part number is:

**X07VOLFORM**

## Chapter 2 – How to connect Formula Steering wheel to EVO

Formula Steering Wheel can be connected to **EVO3 Pro/Pista** and to **EVO4**.

### 2.1 – Connection with EVO3 Pro

To connect the dash use the cable labelled “Exp.” of the 22 pins Deutsch connector logger wiring (optional).

### 2.2 – Connection with EVO3 Pista/EVO4

To connect the dash to **EVO3 Pista** and **EVO4** use the cable labelled “EXP”.

### 2.3 – Connection with other AIM peripherals

Here below is shown the connection between **Formula Steering wheel** and **EVO3 Pro/Pista**, **EVO4** with other AIM peripherals. One or more optional **Data Hub** are required.

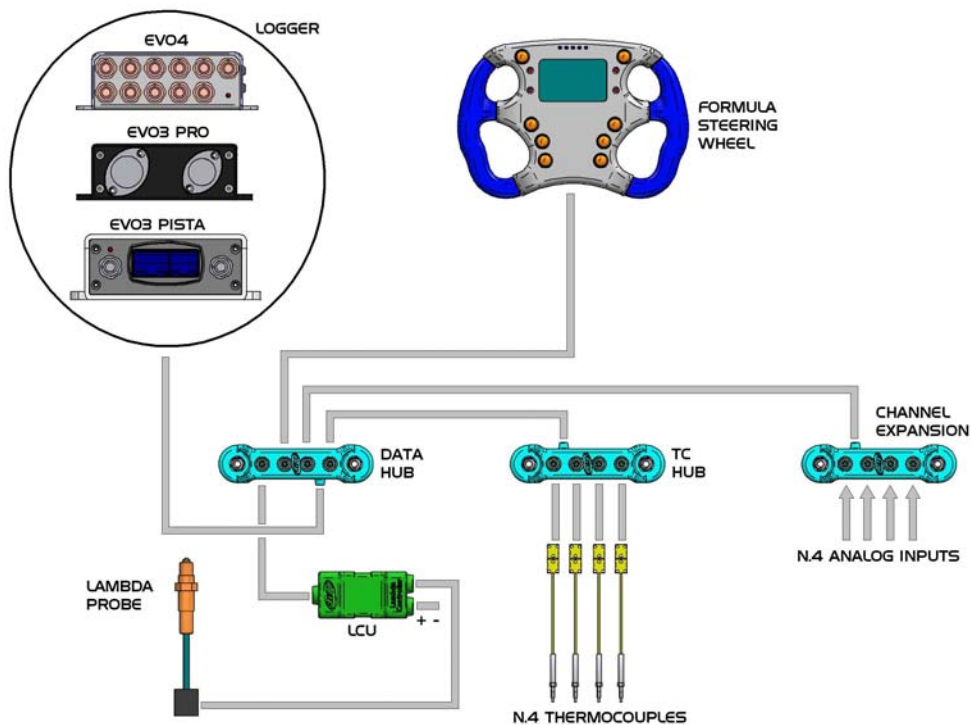

## Chapter 3 – Menu functions

**Formula Steering wheel** for **EVO3 Pro/Pista/EVO4** (from here onward **EVO**) is equipped with an easy and intuitive menu, that can be managed with four buttons. To enter the menu press twice “MENU/←”, highlighted here below.



This screen appears:



It is possible to scroll the menu using the red buttons placed under the display. The correspondence between the buttons and the display functions is highlighted below.



## 3.1 – Backlight



“ENTER” (“MEM/OK” button) enables/disables the backlight.

“PREV”/“NEXT” (“MENU/<<” and “>>” buttons) allows to switch between the options.

“QUIT” (“VIEW” button) quits the menu.

## 3.2 – Control Panel

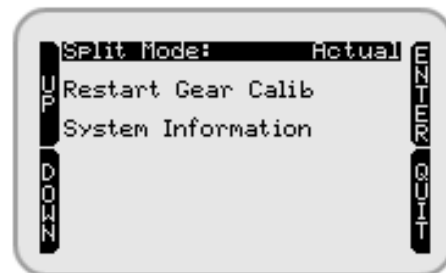
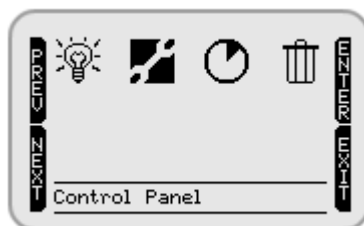

Selecting “Control Panel” and pressing “ENTER” the display shows the screen above on the right.

### 3.2.1 – Split

“ENTER” (“MEM/OK” button) shows the available options in sequence. Press it until the desired option is shown and then press “QUIT” (“VIEW” button). Available options are:

- **None:** split mode is not active.
- **+/- Best:** shows the difference between current lap time and the best one.
- **Actual:** shows actual lap time.
- **Accumulative:** shows the time elapsed between start/finish line and the last split
- **Running LapTime (EVO4 only):** shows the time elapsed from last lap/split signal;
- **Predict Lap (EVO4 only):** shows the predictive lap time;
- **PredictDiff Lap (EVO4 only):** shows the difference between predictive lap time of the current lap and best lap time of the current run.

**Please note:** all split modes except for “None” and “Actual” show lap time for 7 seconds when recorded.

### 3.2.2 – Restart Gear Calib

This option appears only if master logger configuration (**EVO3 PRO/Pista, EVO4**) expects a display (**Formula Steering Wheel**) and calculated gears. This option restarts gear calibration on the master logger through the steering wheel. Refer to **Race Studio Configuration** user manual for further information concerning master logger and displays configuration as well as gear calculation procedure.

### 3.2.3 – System Information

System information page is shown here below:

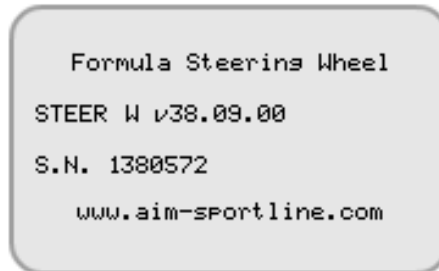

- on top: device name (Formula Steering wheel);
- under this: its firmware version (V 38.09.00);
- then device serial number (1380572)
- on bottom: AIM website address where it is possible to freely download all technical documentation and software and firmware upgrading.

### 3.3 – Hour Meter (EVO4 only)

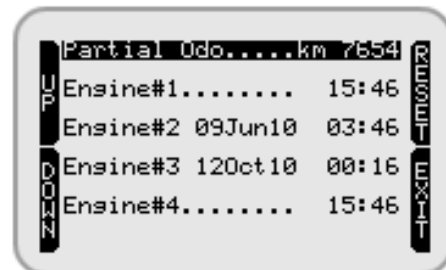
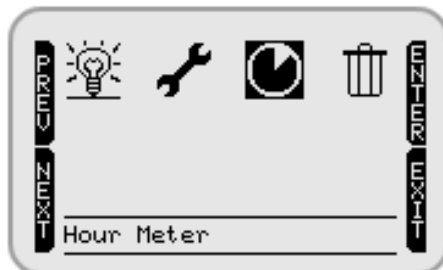

Selecting “Hour Meter” and pressing “Enter” the display shows the page here above on the right.

- **Partial Odo:** resettable odometer. Shows, in km or miles, the run km/miles from last reset.
- **Engine#1-Engine#4:** shows last reset date and hour counter of each engine from last reset.



### 3.4 – Clear Test Data (EVO4 only)

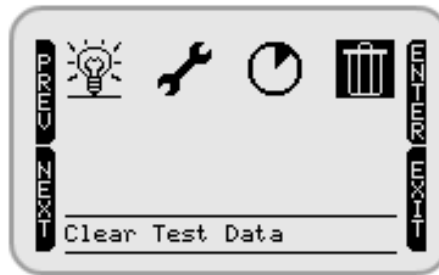

Allows to delete data from the memory of both the display and the master logger: press twice “MEM/OK”.

### 3.5 – How to set GPS Lap timer (EVO4 or EVO3 Pro/Pista with external GPS Module only)

**Formula Steering wheel** allows to use the GPS integrated in **EVO4** as well as an AIM external **GPS Module** connected to **EVO3 Pro/Pista** to sample lap time without having an optical receiver/transmitter. To set GPS Lap timer<sup>1</sup> press “VIEW” button until this screen appears.



Activate “ENTER” command (“MEM/OK” button). This screen appears.

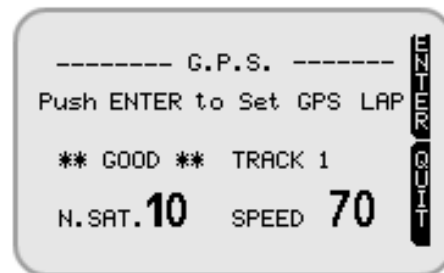

Enter the track with the vehicle, select the physical points where to sample lap and split times and press “ENTER” (“MEM/OK” button).

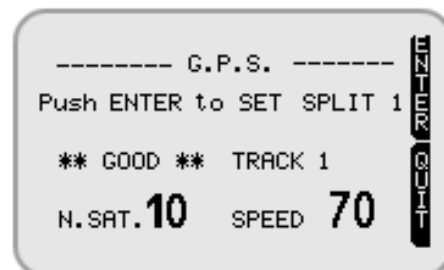

In case split times have been set via software – refer to **Race Studio Configuration** user manual for further information – the screen here on the right appears.

Use “ENTER” (“MEM/OK” button) to set splits. The display shows as many splits as have been set less one, to say if the dash is configured with 6 lap segments user is

<sup>1</sup> In case of an **EVO3 Pro/Pista** ensure that the logger configuration expects an external AIM **GPS Module**.

asked to set 5 splits because the sixth is start/finish line set at the beginning. When the setting is finished the display shows this screen.

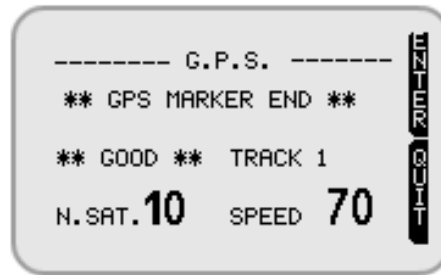

The message "GPS MARKER END" confirms that the procedure is ended successfully. "QUIT" ("VIEW" button) comes back to the main screen. In case during the setting there is a signal fall for any reason the display shows "GPS ERROR" and the procedure is to be repeated.

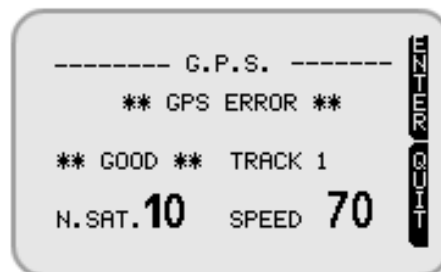

## Chapter 4 – On track visualization

Using on track visualization mode it is possible to keep under control engine and driving performances.



Using “>>” button, highlighted here above, it is possible to see on the right of the display fields 1 and 2 or 3 and 4 set in the software configuration.



Refer to the chapter concerning the dash configuration or to **Race Studio Configuration** user manual – displays chapter, for further information.

## Chapter 5 – Data recall

When a test session is over it is possible to see on the **Formula Steering wheel** data sampled by **EVO**.

Press “MEM/OK” button and **session summary** page appears.

It shows:

- on top: test date with the last test number and the number of laps it is made of.
- over the central table: RPM and Speed Max value.
- in the central table: the three best lap times with lap number, RPM max and min value and speed max value.

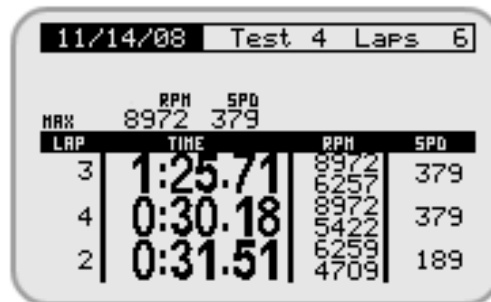

11/14/08 Test 4 Laps 6					
		RPM	SPD		
MAX		8972	379		
LAP	TIME	RPM	SPD		
3	1:25.71	8972	379		
4	0:30.18	6257	379		
2	0:31.51	6259	189		
		4709			

“MENU/>>” and “<<” buttons **scroll the tests**.

Pressing **again** “MEM/OK” button the display shows **Laps Histogram** page, to say the entire test session in a graphic way. The display shows first best lap time and pressing “MENU/>>” and “<<” buttons it is possible to scroll the laps comparing them with the best one. The difference between the selected lap and the best one is shown bottom on the right of the display. In the image below the difference is zero because the selected lap is the best one.

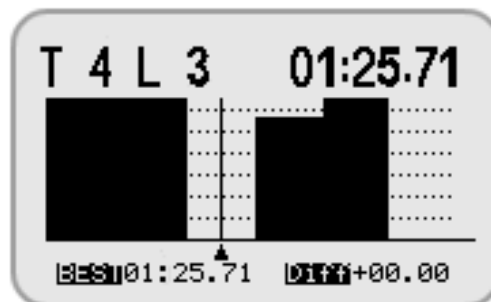

Pressing **again** “MEM/OK” button **Details** page appears. It is divided in three parts.

- Top on the left is test and lap number with max and min RPM and speed values.
- Top on the right is best lap time with the related split times (if sampled).
- Bottom boxes shows the four custom channels with the related max and min values.

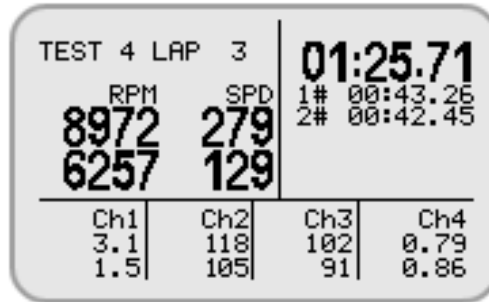

**Warning: transmitting a new configuration to EVO recorded data are deleted.**

## Chapter 6 – Configuring the steering wheel

To configure the **Formula steering wheel**:

- run the software
- select the logger the steering wheel is connected to pressing the corresponding button on the left vertical keyboard of **Race Studio 2** software;
- select the configuration to set the **Formula Steering Wheel** on;
- activate “Display” layer; this screen appears:

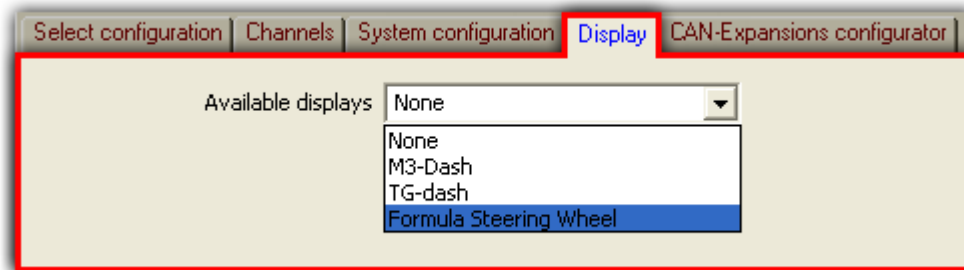

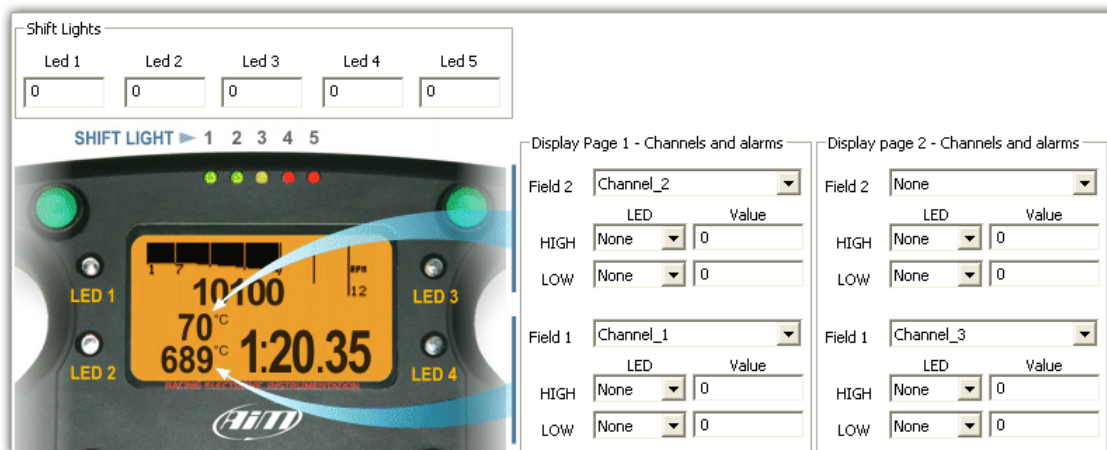

- click on “Available displays” drop down menu and select **Formula Steering Wheel**;
- **Formula Steering wheel** configuration page appears.



Through this window it is possible to set:

- shift lights values:
- channels and alarms fields 1 and 2 within display pages 1 and 2; this means that it is possible to set four channels to display (two by two) and also to connect their max/min threshold values (high/low boxes) to two led that switches on when the set threshold values are reached.

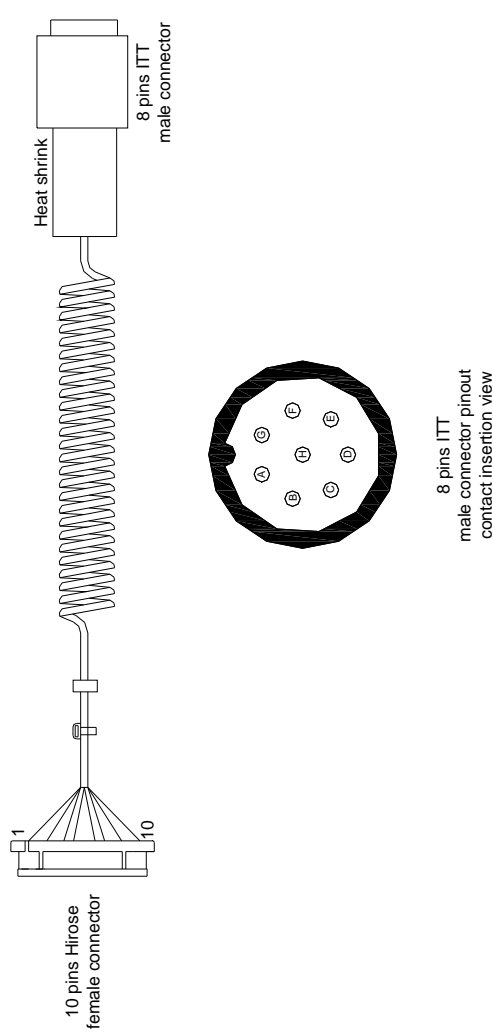
## Appendix – technical drawings

N. rev. / Rev. N.	Descrizione / Description	Data / Date	Firma / Signature	Contr. da / Ckd. by																																																				
<p><b>Harness from Formula steering wheel to car panel</b></p>  <p>10 pins Hirose female connector</p> <p>Heat shrink</p> <p>8 pins ITT male connector</p> <p>8 pins ITT male connector pinout contact insertion view</p>																																																								
<p><b>Cables ending with connectors table</b></p> <table border="1"> <thead> <tr> <th>10 pins Hirose female connector</th> <th>Cable colour</th> <th>8 pins ITT male connector pin</th> <th>Channel</th> <th>Cable type</th> <th>Length</th> </tr> </thead> <tbody> <tr> <td>1</td> <td>Green</td> <td>A</td> <td>CAN 0+</td> <td rowspan="8">8X0.14 mm<sup>2</sup></td> <td rowspan="8">300 mm</td> </tr> <tr> <td>2</td> <td>Grey</td> <td>B</td> <td>GND</td> </tr> <tr> <td>3</td> <td>White</td> <td>C</td> <td>V battery</td> </tr> <tr> <td>4</td> <td>Light blue</td> <td>D</td> <td>CAN 0-</td> </tr> <tr> <td>5</td> <td>Pink</td> <td>E</td> <td>TF4</td> </tr> <tr> <td>6</td> <td>Brown</td> <td>F</td> <td>TF3</td> </tr> <tr> <td>7</td> <td>Yellow</td> <td>G</td> <td>TF2</td> </tr> <tr> <td>8</td> <td>Violet</td> <td>H</td> <td>TF1</td> </tr> <tr> <td>9</td> <td></td> <td></td> <td></td> <td></td> <td></td> </tr> <tr> <td>10</td> <td></td> <td></td> <td></td> <td></td> <td></td> </tr> </tbody> </table>					10 pins Hirose female connector	Cable colour	8 pins ITT male connector pin	Channel	Cable type	Length	1	Green	A	CAN 0+	8X0.14 mm <sup>2</sup>	300 mm	2	Grey	B	GND	3	White	C	V battery	4	Light blue	D	CAN 0-	5	Pink	E	TF4	6	Brown	F	TF3	7	Yellow	G	TF2	8	Violet	H	TF1	9						10					
10 pins Hirose female connector	Cable colour	8 pins ITT male connector pin	Channel	Cable type	Length																																																			
1	Green	A	CAN 0+	8X0.14 mm <sup>2</sup>	300 mm																																																			
2	Grey	B	GND																																																					
3	White	C	V battery																																																					
4	Light blue	D	CAN 0-																																																					
5	Pink	E	TF4																																																					
6	Brown	F	TF3																																																					
7	Yellow	G	TF2																																																					
8	Violet	H	TF1																																																					
9																																																								
10																																																								
Rif. / Ref.	Q.tà/Q.ty	Material / Material	N. articolo / Item N.																																																					
Progettato da / Designed by	Contr. da / Ckd. by	Approvato da / Approved by	Nome file / File name	Data / Date																																																				
LI				Scala / Scale																																																				
		Titolo / Title																																																						
		Cavo da volante Formula a pannello auto																																																						
N. disegno / Drawing N.		Rev. / Rev.	Foglio / Sheet																																																					
04.559.03		2	1 of 1																																																					

N.rev. / Rev. N.	Descrizione / Description	Data / date	Firma / Sign	Contr. da / Ckd. by
------------------	---------------------------	-------------	--------------	---------------------

# Formula Steering wheel harness from car panel to logger

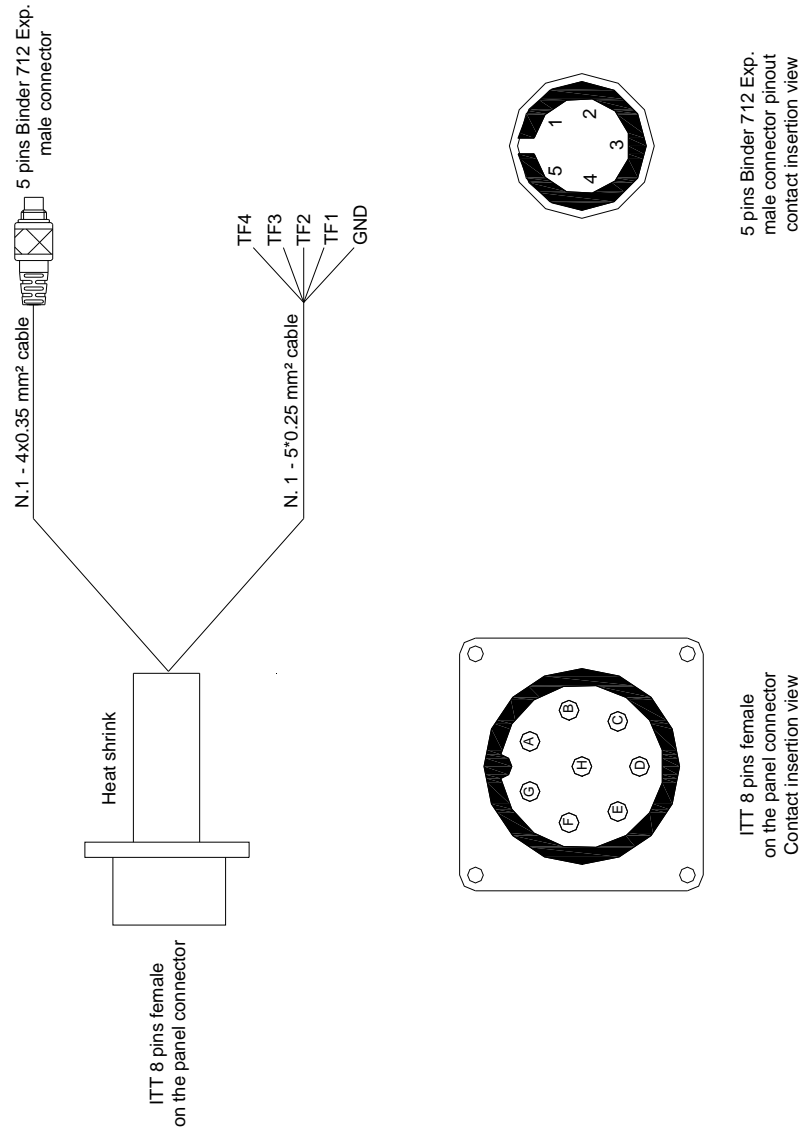

Rif. / Ref.	Q.tà / Q.ty	Materiale / Material		N. articolo / Item N.		
Progettato da / Designed by LI	Contr. da / Ckd. by	Approvato da / Approved by	Nome file / File name	Data / Date	Scala / Scale	
		Titolo / Title Cavo FSW da pannello auto a logger				
		N. disegno / Drawing N. 04.559.02	Rev. / Rev.	Foglio / Sheet 1 of 2		



N.rev. / Rev. N.	Descrizione / Description	Data / date	Firma / Sign	Contr. da / Ckd. by
------------------	---------------------------	-------------	--------------	---------------------

Table 1 - cables ending with a connector

8 pins ITT female on the panel connector pin	Cable colour	Destination connector	Destination connector pin	Cable type	Lenght	Channel	Label
A	white	5 pins Binder 712 Exp. male connector	1	4x0.35 mm <sup>2</sup>	450 mm	CAN 0+ GND V battery CAN 0-	Exp.
B	black		2				
C	red		3				
D	blue		4				
			5				

Table 2 - Not ended cables

8 pins ITT female on the panel connector pin	Cable colour	Cable type	Lenght	Channel
H	white	5x0.25 mm <sup>2</sup>	2350 mm	TF1
G	red			TF2
F	blue			TF3
E	orange			TF4
B	black			GND

Rif. / Ref.	Q.tà / Q.ty	Materiale / Material			N. articolo / Item N.		
Progettato da / Designed by	Contr. da / Ckd. by	Approvato da / Approved by	Nome file / File name		Data / Date	Scala / Scale	
 Racing Data Power		Titolo / Title				Cavo FSW da pannello auto a logger	
		N. disegno / Drawing N.			04.559.02	Rev. / Rev.	Foglio / Sheet

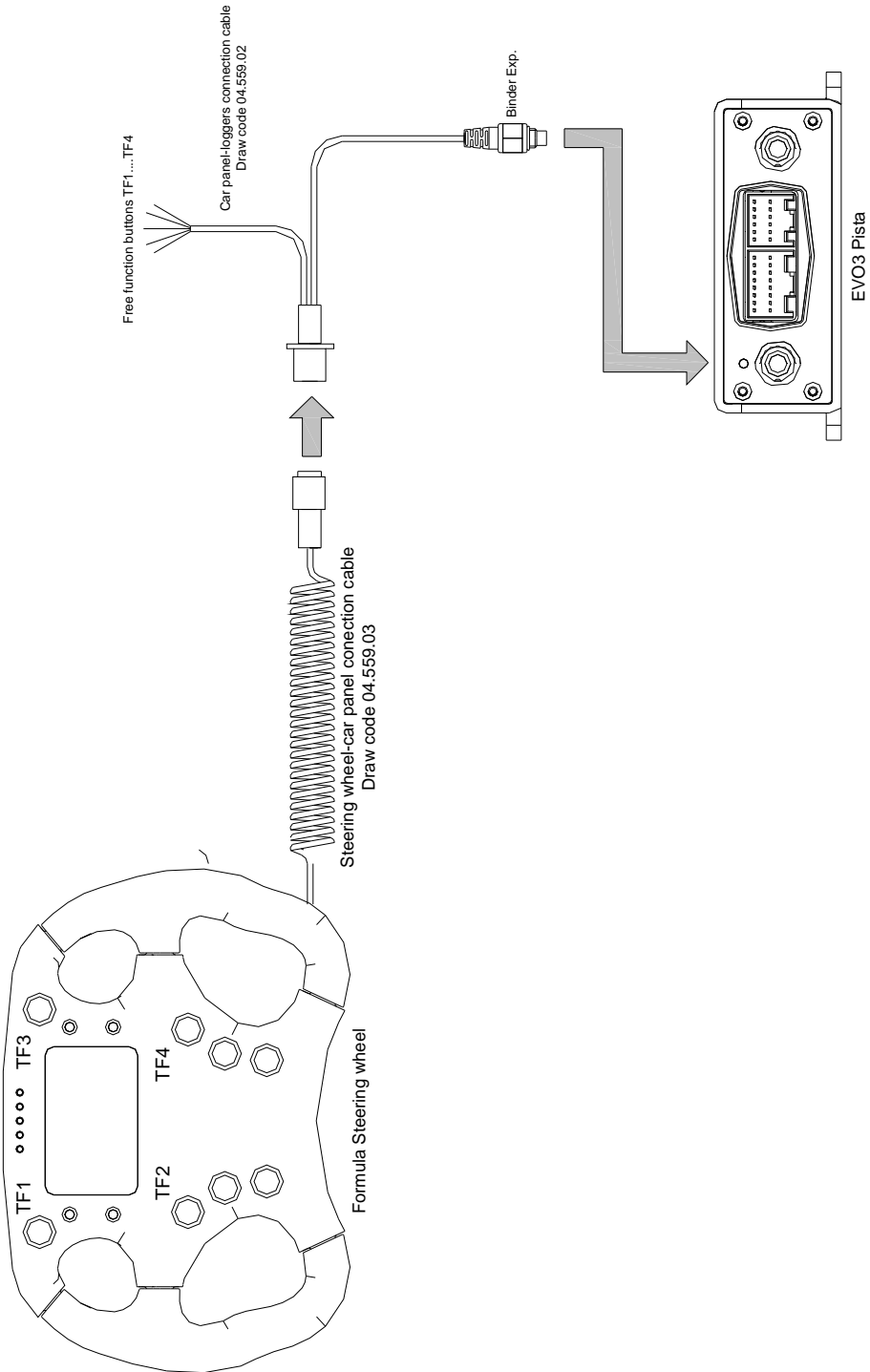

N.rev. / Rev. N.	Descrizione / Description	Data / date	Firma / Sign	Contr. da / Ckd. by
------------------	---------------------------	-------------	--------------	---------------------

## Connection scheme of EVO3 Pista + Formula Steering wheel

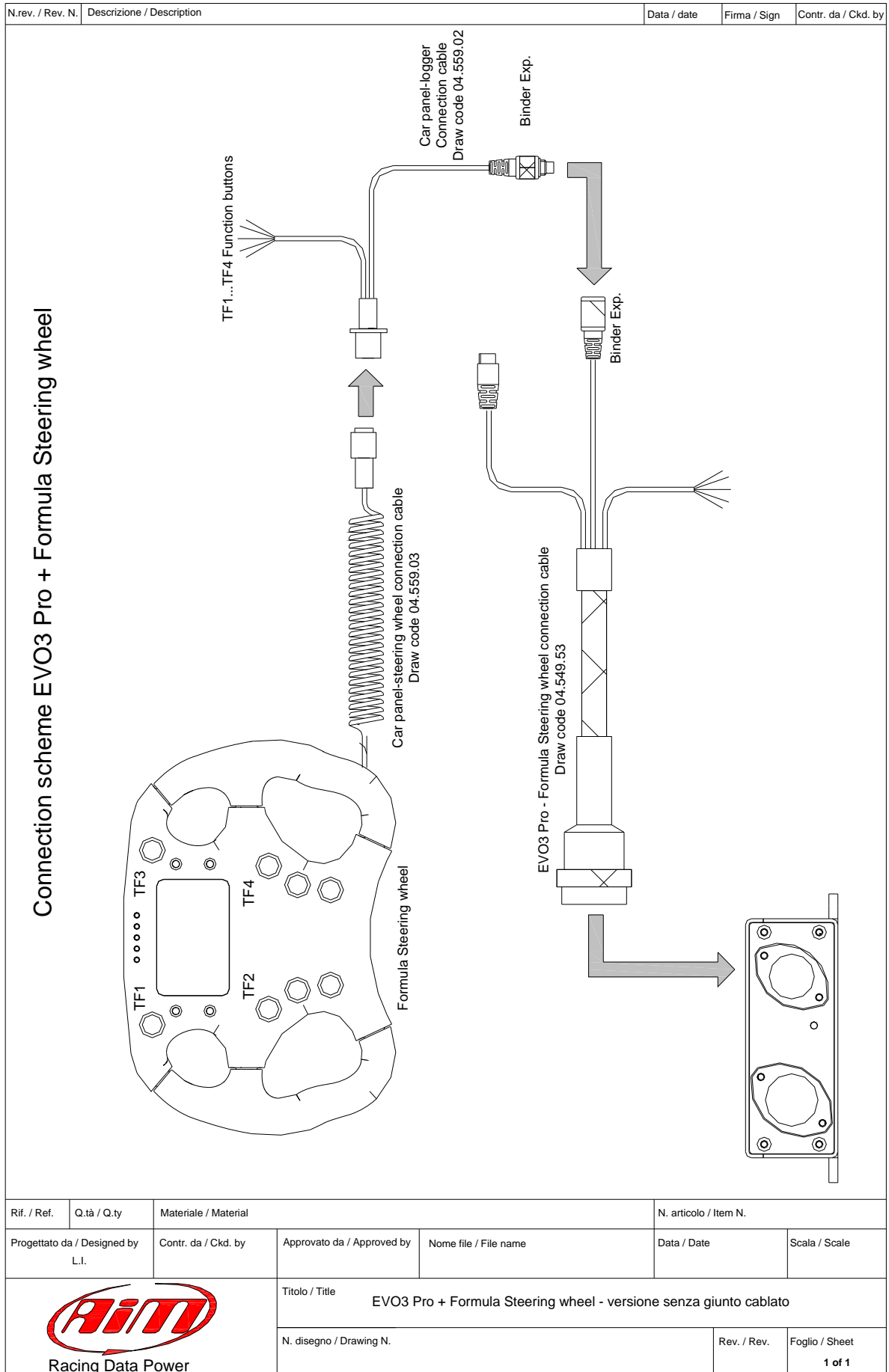

Rif. / Ref.	Q.tà / Q.ty	Materiale / Material		N. articolo / Item N.	
Progettato da / Designed by LI	Contr. da / Ckd. by	Approvato da / Approved by	Nome file / File name	Data / Date	Scala / Scale
 Racing Data Power		Titolo / Title Volante Formula + EVO3 Pista - versione senza giunto cablato			
		N. disegno / Drawing N.		Rev. / Rev.	Foglio / Sheet 1 of 1

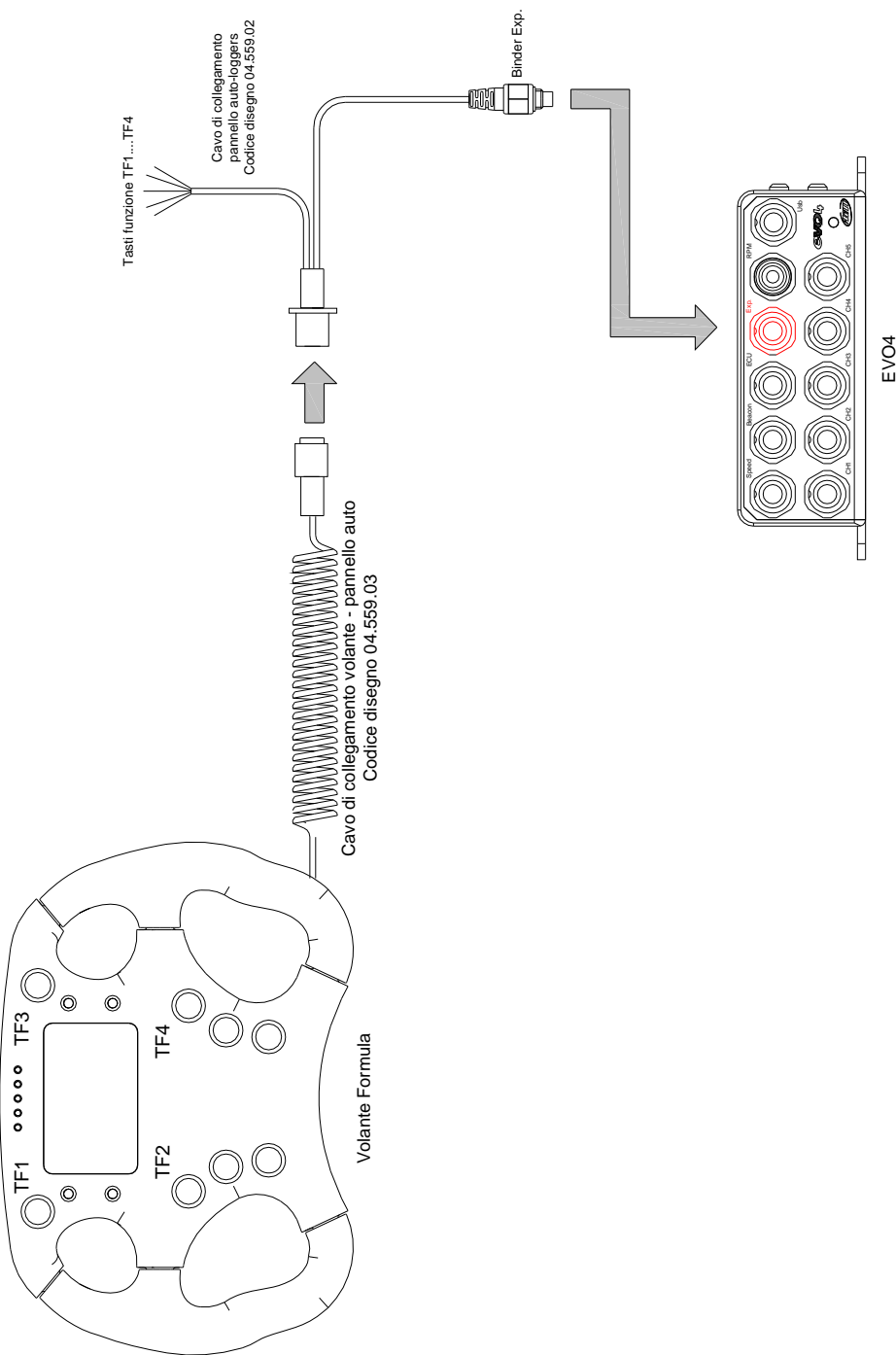

N. rev. / Rev. N.	Descrizione / Description	Data / Date	Firma / Signature	Contr. da / Ckd. by	
<h2 style="writing-mode: vertical-rl; transform: rotate(180deg);">Schema di collegamento EVO4 + Volante Formula</h2> 					
Rif. / Ref.	Q.tà/Q.ty	Material / Material	N. articolo / Item N.		
Progettato da / Designed by LI	Contr. da / Ckd. by	Approvato da / Approved by	Nome file / File name	Data / Date	Scala / Scale
		Titolo / Title Volante Formula + EVO4 - versione senza giunto cablato			
		N. disegno / Drawing N.	Rev. / Rev.	Foglio / Sheet <b>1 di 1</b>	